

TITANIUM

ARTINOX

TITANIUM GUN METAL





TITANIUM 70 GUN METAL

READY



Colander Gun Metal
Athom Tap

17
42

-  Top mount
-  Flush mount
-  Under mount

Cod. **SAT I 70 RA**
Cod. **SATG 70 RA**
Cod. **SATO 70 RA**



TITANIUM 70 GUN METAL

PRO



Colander Gun Metal

17

-  Top mount
-  Flush mount
-  Under mount



Cod. **SBT I 70 RA**
Cod. **SBTG 70 RA**
Cod. **SBTO 70 RA**

TITANIUM 70 GUN METAL

SOLO



Material	AISI 304
Finishing	PVD Gun Metal
Corner radius	Welded 10 mm
Overall dimensions	740 x 440 mm
Basin dimensions	700 x 400 mm
Bowl depth	200 mm
Plus Strainer Gun Metal	Ø 3 1/2"
Cabinet	800 mm

-  Top mount
-  Flush mount
-  Under mount

Cod. **TI 7040 RA**
Cod. **TG 7040 RA**
Cod. **TO 7040 RA**

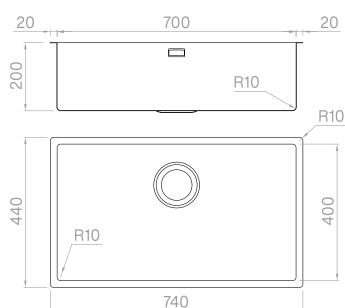

Accessories



See p. 15 for all dedicated accessories.



TITANIUM 50 GUN METAL

READY



Colander Gun Metal
Athom Tap

17
42

-  Top mount
-  Flush mount
-  Under mount

Cod. **SAT I 50 RA**
Cod. **SATG 50 RA**
Cod. **SATO 50 RA**



TITANIUM 50 GUN METAL

PRO



Colander Gun Metal

17

-  Top mount
-  Flush mount
-  Under mount



Cod. **SBT I 50 RA**
Cod. **SBTG 50 RA**
Cod. **SBTO 50 RA**

TITANIUM 50 GUN METAL

SOLO



Material	AISI 304
Finishing	PVD Gun Metal
Corner radius	Welded 10 mm
Overall dimensions	540 x 440 mm
Basin dimensions	500 x 400 mm
Bowl depth	200 mm
Plus Strainer Gun Metal	Ø 3 1/2"
Cabinet	600 mm

-  Top mount
-  Flush mount
-  Under mount

Cod. **TI 5040 RA**
Cod. **TG 5040 RA**
Cod. **TO 5040 RA**

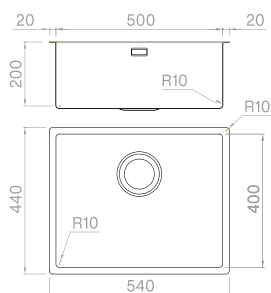

Accessories



See p. 15 for all dedicated accessories.

TITANIUM 40 GUN METAL



READY



Colander Gun Metal
Athom Tap

17

42

-  Top mount
-  Flush mount
-  Under mount

Cod. **SAT I 40 RA**
Cod. **SATG 40 RA**
Cod. **SATO 40 RA**



TITANIUM 40 GUN METAL

PRO



Colander Gun Metal

17

-  Top mount
-  Flush mount
-  Under mount



Cod. **SBT I 40 RA**
Cod. **SBTG 40 RA**
Cod. **SBTO 40 RA**

TITANIUM 40 GUN METAL

SOLO



Material	AISI 304
Finishing	PVD Gun Metal
Corner radius	Welded 10 mm
Overall dimensions	440 x 440 mm
Basin dimensions	400 x 400 mm
Bowl depth	200 mm
Plus Strainer Gun Metal	Ø 3 1/2"
Cabinet	600 mm

-  Top mount
-  Flush mount
-  Under mount

Cod. **TI 4040 RA**
Cod. **TG 4040 RA**
Cod. **TO 4040 RA**

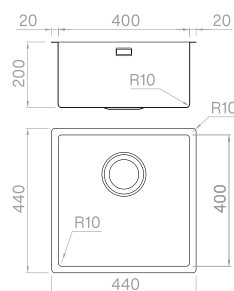

Accessories



See p. 15 for all dedicated accessories.

TITANIUM COPPER BRONZE



TITANIUM 70 COPPER BRONZE

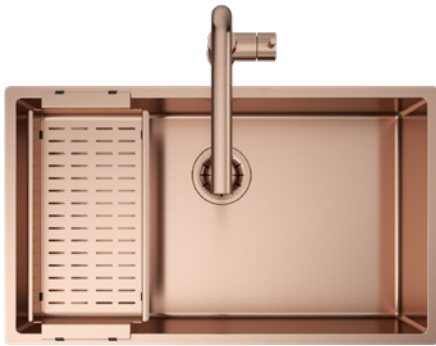

READY



Colander Copper Bronze
Athom Tap

18

43

-  Top mount
-  Flush mount
-  Under mount

Cod. **SAT I 70 RC**
Cod. **SATG 70 RC**
Cod. **SATO 70 RC**



TITANIUM 70 COPPER BRONZE

PRO



Colander Copper Bronze

18

-  Top mount
-  Flush mount
-  Under mount



Cod. **SBT I 70 RC**
Cod. **SBTG 70 RC**
Cod. **SBTO 70 RC**

TITANIUM 70 COPPER BRONZE

SOLO



Material	AISI 304
Finishing	PVD Copper Bronze
Corner radius	Welded 10 mm
Overall dimensions	740 x 440 mm
Basin dimensions	700 x 400 mm
Bowl depth	200 mm
Plus Strainer Copper Bronze	Ø 3 1/2"
Cabinet	800 mm

-  Top mount
-  Flush mount
-  Under mount

Cod. **TI 7040 RC**
Cod. **TG 7040 RC**
Cod. **TO 7040 RC**

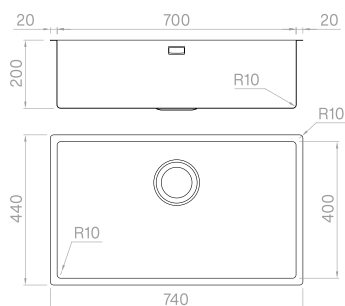

Accessories



See p. 15 for all dedicated accessories.

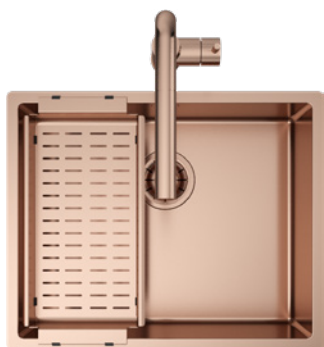

TITANIUM 50 COPPER BRONZE

READY



Colander Copper Bronze
Athom Tap

18
43

-  Top mount
-  Flush mount
-  Under mount

Cod. **SAT I 50 RC**
Cod. **SATG 50 RC**
Cod. **SATO 50 RC**



TITANIUM 50 COPPER BRONZE

PRO



Colander Copper Bronze

18

-  Top mount
-  Flush mount
-  Under mount



Cod. **SBT I 50 RC**
Cod. **SBTG 50 RC**
Cod. **SBTO 50 RC**

TITANIUM 50 COPPER BRONZE

SOLO



Material	AISI 304
Finishing	PVD Copper Bronze
Corner radius	Welded 10 mm
Overall dimensions	540 x 440 mm
Basin dimensions	500 x 400 mm
Bowl depth	200 mm
Plus Strainer Copper Bronze	Ø 3 1/2"
Cabinet	600 mm

-  Top mount
-  Flush mount
-  Under mount

Cod. **TI 5040 RC**
Cod. **TG 5040 RC**
Cod. **TO 5040 RC**

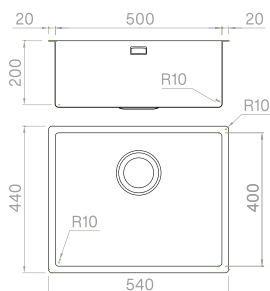

Accessories



See p. 15 for all dedicated accessories.

TITANIUM 40 COPPER BRONZE



READY



Colander Copper Bronze
Athom Tap

18

43

-  Top mount
-  Flush mount
-  Under mount

Cod. **SAT I 40 RC**
Cod. **SATG 40 RC**
Cod. **SATO 40 RC**



TITANIUM 40 COPPER BRONZE

PRO



Colander Copper Bronze

18

-  Top mount
-  Flush mount
-  Under mount



Cod. **SBT I 40 RC**
Cod. **SBTG 40 RC**
Cod. **SBTO 40 RC**

TITANIUM 40 COPPER BRONZE

SOLO



Material	AISI 304
Finishing	PVD Copper Bronze
Corner radius	Welded 10 mm
Overall dimensions	440 x 440 mm
Basin dimensions	400 x 400 mm
Bowl depth	200 mm
Plus Strainer Copper Bronze	Ø 3 1/2"
Cabinet	600 mm

-  Top mount
-  Flush mount
-  Under mount

Cod. **TI 4040 RC**
Cod. **TG 4040 RC**
Cod. **TO 4040 RC**

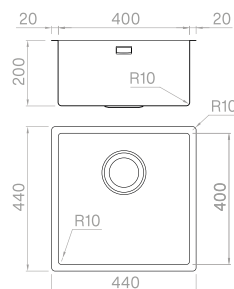

Accessories



See p. 15 for all dedicated accessories.

TITANIUM PALE GOLD





TITANIUM 70 PALE GOLD

READY



Colander Pale Gold
Athom Tap

19
44

-  Top mount
-  Flush mount
-  Under mount

Cod. **SAT I 70 RG**
Cod. **SATG 70 RG**
Cod. **SATO 70 RG**



TITANIUM 70 PALE GOLD

PRO



Colander Pale Gold

19

-  Top mount
-  Flush mount
-  Under mount



Cod. **SBT I 70 RG**
Cod. **SBTG 70 RG**
Cod. **SBTO 70 RG**

TITANIUM 70 PALE GOLD

SOLO



Material	AISI 304
Finishing	PVD Pale Gold
Corner radius	Welded 10 mm
Overall dimensions	740 x 440 mm
Basin dimensions	700 x 400 mm
Bowl depth	200 mm
Plus Strainer Pale Gold	Ø 3 1/2"
Cabinet	800 mm

-  Top mount
-  Flush mount
-  Under mount

Cod. **TI 7040 RG**
Cod. **TG 7040 RG**
Cod. **TO 7040 RG**

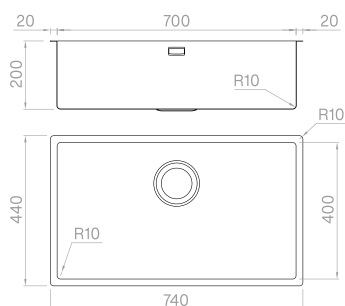

Accessories



See p. 15 for all dedicated accessories.

TITANIUM 50 PALE GOLD



READY



Colander Pale Gold
Athom Tap

19

44

-  Top mount
-  Flush mount
-  Under mount

Cod. **SAT I 50 RG**
Cod. **SATG 50 RG**
Cod. **SATO 50 RG**



TITANIUM 50 PALE GOLD

PRO



Colander Pale Gold

19

-  Top mount
-  Flush mount
-  Under mount



Cod. **SBT I 50 RG**
Cod. **SBTG 50 RG**
Cod. **SBTO 50 RG**

TITANIUM 50 PALE GOLD

SOLO



Material	AISI 304
Finishing	PVD Pale Gold
Corner radius	Welded 10 mm
Overall dimensions	540 x 440 mm
Basin dimensions	500 x 400 mm
Bowl depth	200 mm
Plus Strainer Pale Gold	Ø 3 1/2"
Cabinet	600 mm

-  Top mount
-  Flush mount
-  Under mount

Cod. **TI 5040 RG**
Cod. **TG 5040 RG**
Cod. **TO 5040 RG**

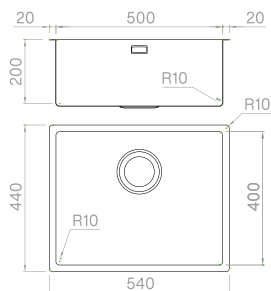

Accessories



See p. 15 for all dedicated accessories.

TITANIUM 40 PALE GOLD



READY



Colander Pale Gold
Athom Tap

19

44

-  Top mount
-  Flush mount
-  Under mount

Cod. **SAT I 40 RG**

Cod. **SATG 40 RG**

Cod. **SATO 40 RG**



TITANIUM 40 PALE GOLD

PRO



Colander Pale Gold

19

-  Top mount
-  Flush mount
-  Under mount

Cod. **SBT I 40 RG**

Cod. **SBTG 40 RG**



Cod. **SBTO 40 RG**

TITANIUM 40 PALE GOLD

SOLO



Material	AISI 304
Finishing	PVD Pale Gold
Corner radius	Welded 10 mm
Overall dimensions	440 x 440 mm
Basin dimensions	400 x 400 mm
Bowl depth	200 mm
Plus Strainer Pale Gold	Ø 3 1/2"
Cabinet	600 mm

-  Top mount
-  Flush mount
-  Under mount

Cod. **TI 4040 RG**

Cod. **TG 4040 RG**

Cod. **TO 4040 RG**

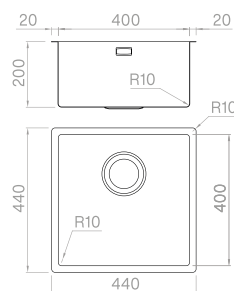

Accessories



See p. 15 for all dedicated accessories.



Wooden chopping board**3**

300x420x20 mm
Cod. **TRIB 3042**

**HDPE chopping board****6**

240x420x20 mm
Cod. **TRP 2442**

**Colander Gun Metal****17**

210x420x60 mm
Cod. **VQAF 2142**

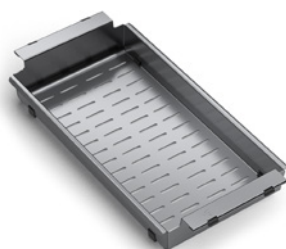
**Colander Copper Bronze****18**

210x420x60 mm
Cod. **VQCF 2142**

**Colander Pale Gold****19**

210x420x60 mm
Cod. **VQGF 2142**

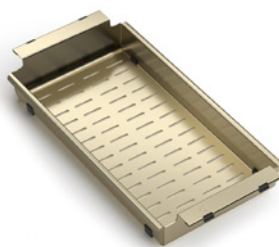
**Gastronorm set****30**

240x420x100 mm
Cod. **TI 2442 V**

**Strainer set****32**

240x420x100 mm
Cod. **TI 2442 1S**

**Slicer/grater set****34**

240x420x28 mm
Cod. **TI 2442 PG**



Disclaimer

Each product in this catalog is manufactured in compliance to current regulations and CE directives.

All data shown are not binding.

Artinox S.p.a. reserves the right to make changes deemed useful for the improvement of its offer at any time, without notice and disclaiming any responsibility for errors or inaccuracies.

The reproduction of the colors in the catalog are to be considered indicative. Reproductions of all or part of this catalog are prohibited without the specific written authorization of Artinox S.p.a.

© Copyright 2023 Artinox S.p.a. - All rights reserved.

Artinox SpA

Via F. Fabbrì, 39 z.i. Campidui

31015 Conegliano (TV)

Italy

Tel. +39 0438 4531

Mail

Artinox S.p.a. is certified UNI EN ISO 9001 and UNI EN ISO 14001



