

LAYER

ARTINOX

LAYER BRL





LAYER BRL 104

READY



- Wooden chopping board
- Colander
- Grid
- Element Tap

- 4
- 48
- 14
- 40

-  Top mount
-  Under mount

Cod. **SA BRL I 10**
Cod. **SA BRLO 10**



LAYER BRL 104

PRO



- Wooden chopping board
- Colander

- 4
- 48

-  Top mount
-  Under mount

Cod. **SB BRL I 10**
Cod. **SB BRLO 10**

LAYER BRL 104

SOLO



- Material AISI 304
- Finishing Brushed
- Corner radius '0' Radius angle
- Overall dimensions 1080 x 510 mm
- Basin dimensions 960 x 410 mm
- Bowl depth 230 mm
- Plus Strainer Ø 3 1/2"
- Cabinet 1200 mm

-  Top mount
-  Under mount

Cod. **AL BRL I 10**
Cod. **AL BRLO 10**

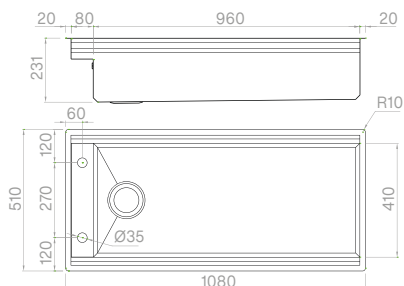

Accessories

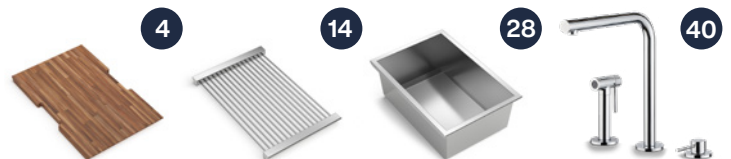

See p. 6 for all dedicated accessories.

LAYER BRL 74

READY



- Wooden chopping board
- Colander
- Element Tap

4
48
40



Cod. **SA BRL I 74**
Cod. **SA BRLO 74**

LAYER BRL 74

PRO



- Wooden chopping board

4

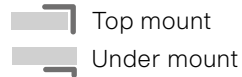

Cod. **SB BRL I 74**
Cod. **SB BRLO 74**

LAYER BRL 74

SOLO



- Material AISI 304
- Finishing Brushed
- Corner radius '0' Radius angle
- Overall dimensions 780 x 510 mm
- Basin dimensions 660 x 410 mm
- Bowl depth 230 mm
- Plus Strainer Ø 3 1/2"
- Cabinet 900 mm



Cod. **AL BRL I 74**
Cod. **AL BRLO 74**

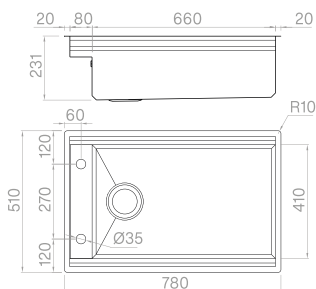

Accessories

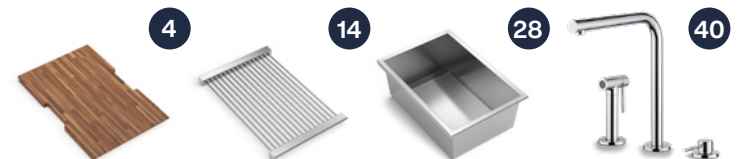

See p. 6 for all dedicated accessories.



Wooden chopping board

4

345x465x19 mm
Cod. **TBRL 4634**



Grid

14

300x465x25 mm
Cod. **GFL 4630**



Colander

21

190x435x80 mm
Cod. **VFPB RL19**



Basin

28

345x435x160 mm
Cod. **VGB RL34**



Colander

48

345x435x80 mm
Cod. **VFGB RL34**



LAYER BRP



LAYER BRP 104

READY

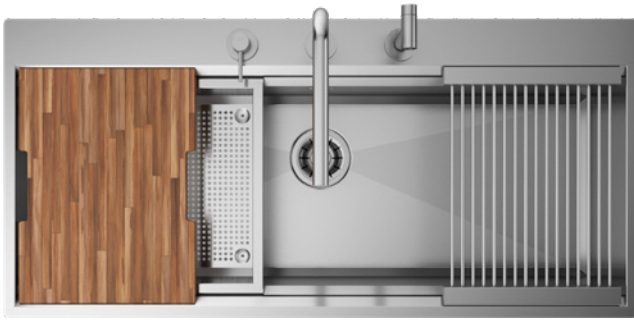

- Wooden chopping board
- Colander
- Grid
- Element Tap

- 5
- 49
- 15
- 40

 Top mount

Cod. **SA BRP 104**

LAYER BRP 104

PRO



- Wooden chopping board
- Colander

- 5
- 49

 Top mount

Cod. **SB BRP 104**

LAYER BRP 104

SOLO



- | | |
|--------------------|------------------|
| Material | AISI 304 |
| Finishing | Brushed |
| Corner radius | '0' Radius angle |
| Overall dimensions | 1080 x 510 mm |
| Basin dimensions | 1040 x 350 mm |
| Bowl depth | 210 mm |
| Plus Strainer | Ø 3 1/2" |
| Cabinet | 1200 mm |

 Top mount

Cod. **AL BRP 104**

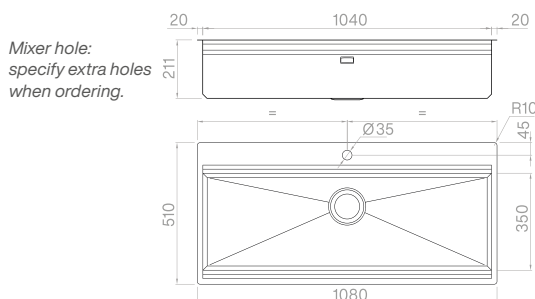

Accessories



See p. 23 for all dedicated accessories.

LAYER BRP 81

READY

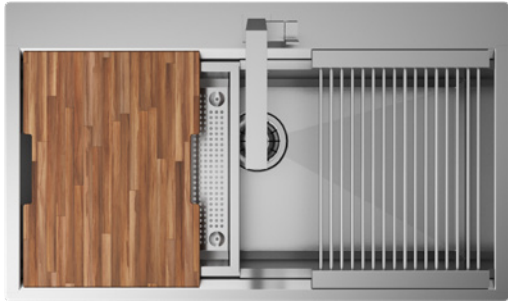

- Wooden chopping board
- Colander
- Grid
- Vertigo Tap

- 5
- 49
- 15
- 47



Cod. **SA BRP 81**

LAYER BRP 81

PRO

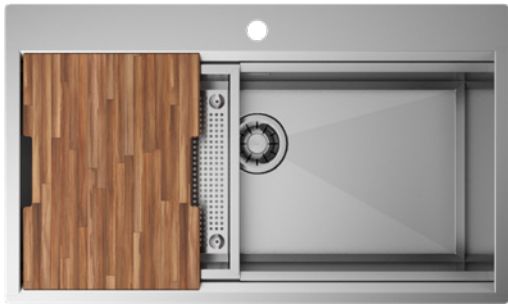

- Wooden chopping board
- Colander

- 5
- 49



Cod. **SB BRP 81**

LAYER BRP 81

SOLO

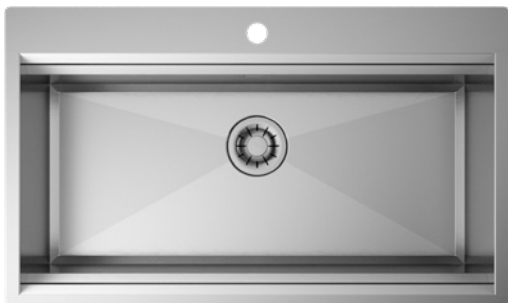

- | | |
|--------------------|------------------|
| Material | AISI 304 |
| Finishing | Brushed |
| Corner radius | '0' Radius angle |
| Overall dimensions | 850 x 510 mm |
| Basin dimensions | 810 x 350 mm |
| Bowl depth | 210 mm |
| Plus Strainer | Ø 3 1/2" |
| Cabinet | 900 mm |



Cod. **AL BRP 81**

Mixer hole: specify extra holes when ordering.

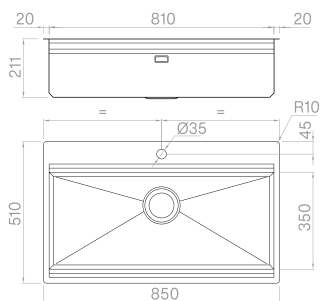

Accessories



See p. 23 for all dedicated accessories.

LAYER BRP 70

READY

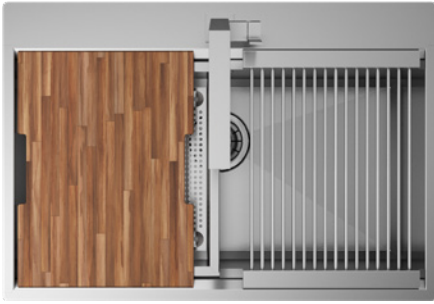

- Wooden chopping board
- Colander
- Grid
- Vertigo Tap

- 5
- 22
- 15
- 47



Cod. SA BRP 70

LAYER BRP 70

PRO



- Wooden chopping board
- Colander

- 5
- 22



Cod. SB BRP 70

LAYER BRP 70

SOLO



- | | |
|--------------------|------------------|
| Material | AISI 304 |
| Finishing | Brushed |
| Corner radius | '0' Radius angle |
| Overall dimensions | 740 x 510 mm |
| Basin dimensions | 700 x 350 mm |
| Bowl depth | 210 mm |
| Plus Strainer | Ø 3 1/2" |
| Cabinet | 800 mm |



Cod. AL BRP 70

Mixer hole: specify extra holes when ordering.

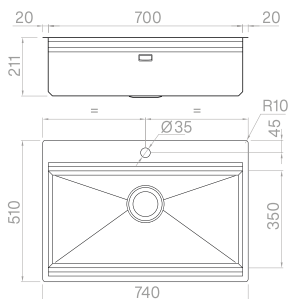

Accessories



See p. 23 for all dedicated accessories.

LAYER BRP 65

READY



Wooden chopping board
Colander
Vertigo Tap

5
22
47



Cod. SA BRP 65

LAYER BRP 65

PRO



Wooden chopping board

5



Cod. SB BRP 65

LAYER BRP 65

SOLO



Material	AISI 304
Finishing	Brushed
Corner radius	'0' Radius angle
Overall dimensions	690 x 510 mm
Basin dimensions	600 x 350 mm
Bowl depth	210 mm
Plus Strainer	Ø 3 1/2"
Cabinet	750 mm



Cod. AL BRP 65

Mixer hole: specify extra holes when ordering.

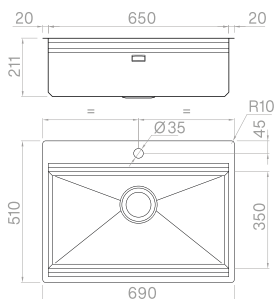

Accessories

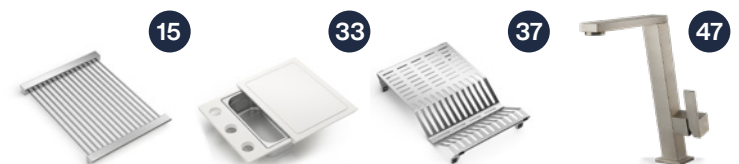

See p. 23 for all dedicated accessories.

LAYER BRP 50

READY



- Wooden chopping board
- Colander
- Vertigo Tap

- 5
- 22
- 47



Cod. SA BRP 50

LAYER BRP 50

PRO



- Wooden chopping board

- 5



Cod. SB BRP 50

LAYER BRP 50

SOLO



- | | |
|--------------------|------------------|
| Material | AISI 304 |
| Finishing | Brushed |
| Corner radius | '0' Radius angle |
| Overall dimensions | 540 x 510 mm |
| Basin dimensions | 500 x 350 mm |
| Bowl depth | 210 mm |
| Plus Strainer | Ø 3 1/2" |
| Cabinet | 600 mm |



Cod. AL BRP 50

Mixer hole: specify extra holes when ordering.

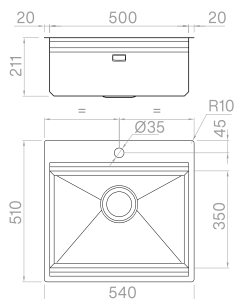

Accessories



See p. 23 for all dedicated accessories.

LAYER SP



LAYER SP 81

READY

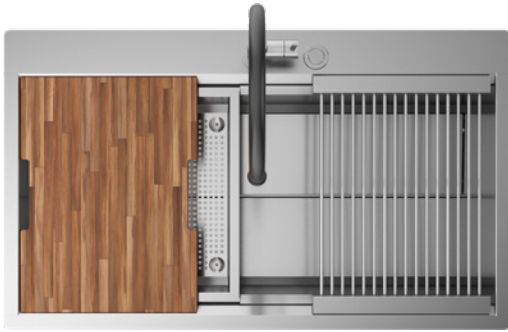

- Wooden chopping board
- Colander
- Grid
- Hero Tap

- 5
- 49
- 15
- 39



Cod. **SA BR81 SP**

LAYER SP 81

PRO



- Wooden chopping board
- Colander

- 5
- 49



Cod. **SB BR81 SP**

LAYER SP 81

SOLO



- | | |
|------------------------|------------------|
| Material | AISI 304 |
| Finishing | Brushed |
| Corner radius | '0' Radius angle |
| Overall dimensions | 860 x 510 mm |
| Basin dimensions | 810 x 350 mm |
| Bowl depth | 210 mm |
| Standard Strainer | Ø 3 1/2" |
| Automated drain system | Included |
| Cabinet | 900 mm |



Cod. **AL BR81 SP**

Mixer hole: specify extra holes when ordering.

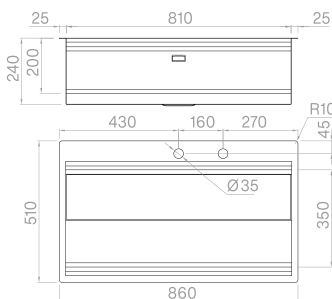

Accessories



See p. 23 for all dedicated accessories.

LAYER SP 70

READY



- Wooden chopping board
- Colander
- Grid
- Hero Tap

- 5
- 22
- 15
- 39



Cod. **SA BR70 SP**

LAYER SP 70

PRO



- Wooden chopping board
- Colander

- 5
- 22



Cod. **SB BR70 SP**

LAYER SP 70

SOLO



- | | |
|------------------------|------------------|
| Material | AISI 304 |
| Finishing | Brushed |
| Corner radius | '0' Radius angle |
| Overall dimensions | 750 x 510 mm |
| Basin dimensions | 700 x 350 mm |
| Bowl depth | 210 mm |
| Standard Strainer | Ø 3 1/2" |
| Automated drain system | Included |
| Cabinet | 800 mm |



Cod. **AL BR70 SP**

Mixer hole: specify extra holes when ordering.

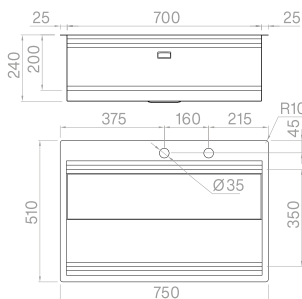

Accessories



See p. 23 for all dedicated accessories.

LAYER SBR



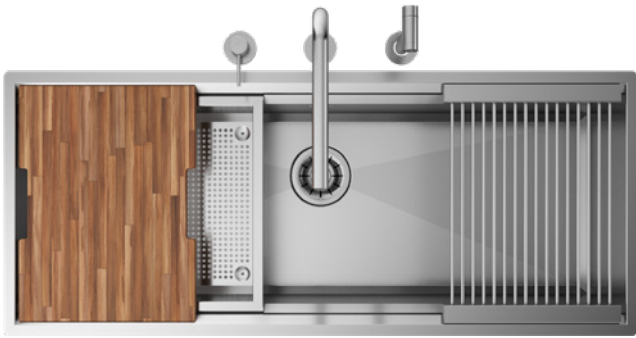

LAYER SBR 104

READY



- Wooden chopping board
- Colander
- Grid
- Element Tap

- 5
- 49
- 15
- 40

-  Top mount
-  Under mount

Cod. **SA SBR 104**
Cod. **SA SBR ST1**

LAYER SBR 104

PRO

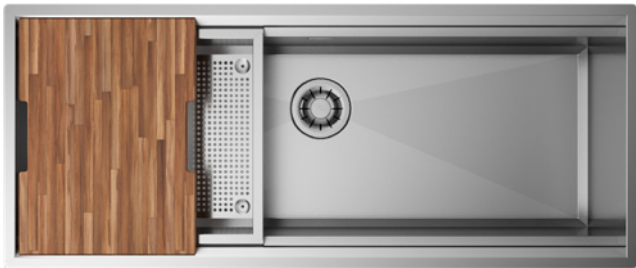

- Wooden chopping board
- Colander

- 5
- 49

-  Top mount
-  Under mount

Cod. **SB SBR 104**
Cod. **SB SBR ST1**

LAYER SBR 104

SOLO



- Material AISI 304
- Finishing Brushed
- Corner radius '0' Radius angle
- Overall dimensions 1080 x 450 mm
- Basin dimensions 1040 x 350 mm
- Bowl depth 210 mm
- Plus Strainer Ø 3 1/2"
- Cabinet 1200 mm

-  Top mount
-  Under mount

Cod. **SBR 104**
Cod. **SBR ST 104**

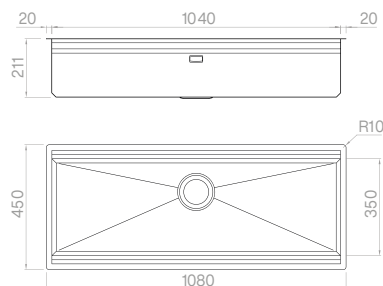

Accessories



See p. 23 for all dedicated accessories.

LAYER SBR 81

READY

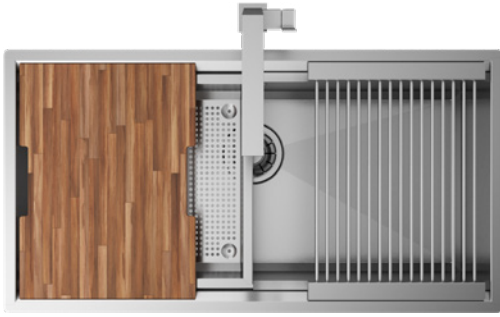

- Wooden chopping board
- Colander
- Grid
- Vertigo Tap

- 5
- 49
- 15
- 47



Cod. **SA SBR 81**
Cod. **SA SBR ST8**

LAYER SBR 81

PRO



- Wooden chopping board
- Colander

- 5
- 49



Cod. **SB SBR 81**
Cod. **SB SBR ST8**

LAYER SBR 81

SOLO



Material	AISI 304
Finishing	Brushed
Corner radius	'0' Radius angle
Overall dimensions	850 x 450 mm
Basin dimensions	810 x 350 mm
Bowl depth	210 mm
Plus Strainer	Ø 3 1/2"
Cabinet	900 mm

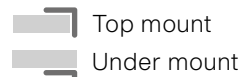

Cod. **SBR 81**
Cod. **SBR ST 81**

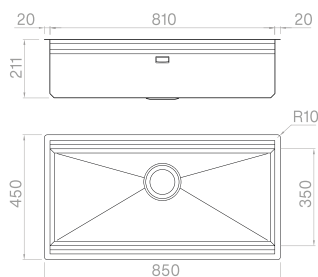

Accessories



See p. 23 for all dedicated accessories.

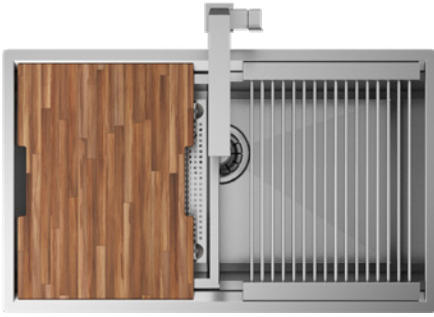

LAYER SBR 70

READY



- Wooden chopping board
- Colander
- Grid
- Vertigo Tap

- 5
- 22
- 15
- 47

-  Top mount
-  Under mount

Cod. **SA SBR 70**
Cod. **SA SBR ST7**



LAYER SBR 70

PRO



- Wooden chopping board
- Colander

- 5
- 22

-  Top mount
-  Under mount

Cod. **SB SBR 70**
Cod. **SB SBR ST7**

LAYER SBR 70

SOLO



- Material AISI 304
- Finishing Brushed
- Corner radius '0' Radius angle
- Overall dimensions 740 x 450 mm
- Basin dimensions 700 x 350 mm
- Bowl depth 210 mm
- Plus Strainer Ø 3 1/2"
- Cabinet 800 mm

-  Top mount
-  Under mount

Cod. **SBR 70**
Cod. **SBR ST 70**

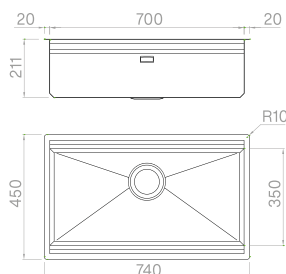

Accessories

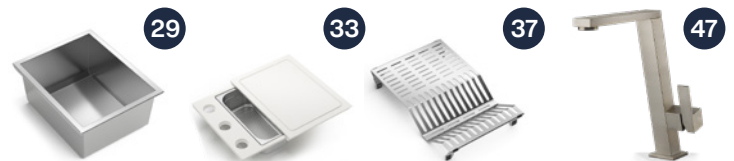

See p. 23 for all dedicated accessories.

LAYER SBR 65

READY



Wooden chopping board
Colander
Vertigo Tap

5
22
47



Cod. **SA SBR 65**
Cod. **SA SBR ST6**

LAYER SBR 65

PRO



Wooden chopping board

5

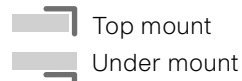

Cod. **SB SBR 65**
Cod. **SB SBR ST6**

LAYER SBR 65

SOLO



Material	AISI 304
Finishing	Brushed
Corner radius	'0' Radius angle
Overall dimensions	690 x 450 mm
Basin dimensions	650 x 350 mm
Bowl depth	210 mm
Plus Strainer	Ø 3 1/2"
Cabinet	750 mm



Cod. **SBR 65**
Cod. **SBR ST 65**

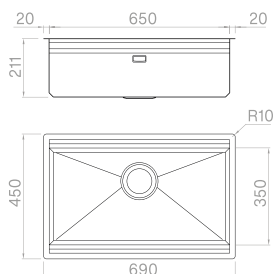

Accessories



See p. 23 for all dedicated accessories.

LAYER SBR 50

READY



Wooden chopping board
Colander
Vertigo Tap

5
22
47

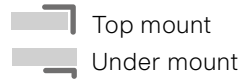

Cod. **SA SBR 50**
Cod. **SA SBR ST5**

LAYER SBR 50

PRO



Wooden chopping board

5



Cod. **SB SBR 50**
Cod. **SB SBR ST5**

LAYER SBR 50

SOLO



Material	AISI 304
Finishing	Brushed
Corner radius	'0' Radius angle
Overall dimensions	540 x 450 mm
Basin dimensions	500 x 350 mm
Bowl depth	210 mm
Plus Strainer	Ø 3 1/2"
Cabinet	600 mm



Cod. **SBR 50**
Cod. **SBR ST 50**

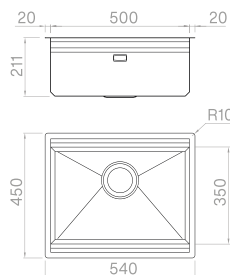

Accessories

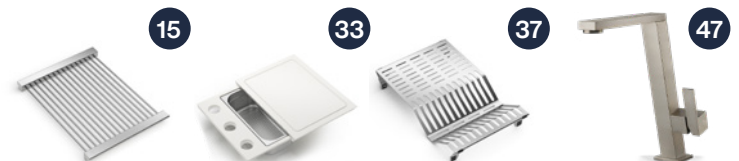

See p. 23 for all dedicated accessories.



Wooden chopping board**5**

300x405x19 mm
Cod. **TSBR 4030**

**Grid****15**

300x405x25 mm
Cod. **GFL 4030**

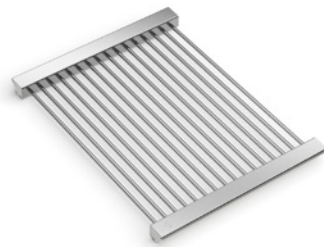
**Colander****22**

190x375x80 mm
Cod. **VFP SBR19**

**Basin****29**

300x375x160 mm
Cod. **VGS BR34**

**Chopping board +
gastronorm set****31**

300x405x100 mm
Cod. **TPLB 3V**

**Chopping board +
pasta strainer set****33**

300x405x100 mm
Cod. **TPLB 1S**

**Chopping board +
knife holder frame set****35**

300x405x20 mm
Cod. **TPLB 4030**

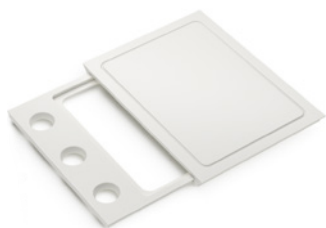
**Dish holder****37**

250x400x55 mm
Cod. **PPPB SBR**

**Colander****49**

300x375x80 mm
Cod. **VFG SBR34**



Disclaimer

Each product in this catalog is manufactured in compliance to current regulations and CE directives.

All data shown are not binding.

Artinox S.p.a. reserves the right to make changes deemed useful for the improvement of its offer at any time, without notice and disclaiming any responsibility for errors or inaccuracies.

The reproduction of the colors in the catalog are to be considered indicative. Reproductions of all or part of this catalog are prohibited without the specific written authorization of Artinox S.p.a.

© Copyright 2023 Artinox S.p.a. - All rights reserved.

Artinox SpA

Via F. Fabbrì, 39 z.i. Campidui

31015 Conegliano (TV)

Italy

Tel. +39 0438 4531

Mail

Artinox S.p.a. is certified UNI EN ISO 9001 and UNI EN ISO 14001



